

## LOW LEAKAGE DIODE

### FEATURES

- Low Leakage
- High Conductance

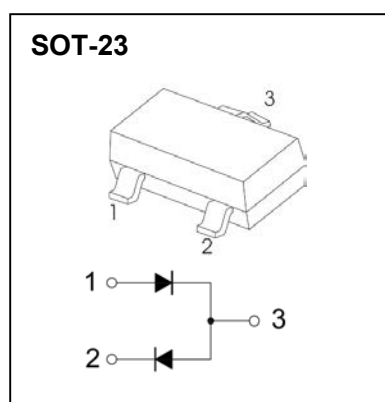

### MAXIMUM RATINGS ( $T_a=25^{\circ}\text{C}$ unless otherwise noted )

Symbol	Parameter	Value	Unit
$V_R$	DC Blocking Voltage	200	V
$I_O$	Continuous Forward Current	200	mA
$I_{FM}$	Peak Forward Current	700	mA
$I_{FSM}$	Non-repetitive Peak Forward Surge Current @ $t=8.3\text{ms}$	2.0	A
$P_D$	Power Dissipation	350	mW
$R_{\theta JA}$	Thermal Resistance from Junction to Ambient	357	$^{\circ}\text{C}/\text{W}$
$T_J, T_{stg}$	Operation Junction and Storage Temperature Range	-55~+150	$^{\circ}\text{C}$

### ELECTRICAL CHARACTERISTICS( $T_a=25^{\circ}\text{C}$ unless otherwise specified)

Parameter	Symbol	Test conditions	Min	Typ	Max	Unit
Reverse voltage	$V_{(BR)}$	$I_R=5\mu\text{A}$	200			V
Reverse current	$I_R$	$V_R=180\text{V}$			10	nA
Forward voltage	$V_F$	$I_F=1\text{mA}$			0.75	V
		$I_F=10\text{mA}$			0.85	
		$I_F=50\text{mA}$			0.95	
		$I_F=100\text{mA}$			1.1	
		$I_F=200\text{mA}$			1.3	
		$I_F=300\text{mA}$			1.5	
Total capacitance	$C_{tot}$	$V_R=0\text{V}, f=1\text{MHz}$			4	pF

## Typical Characteristics

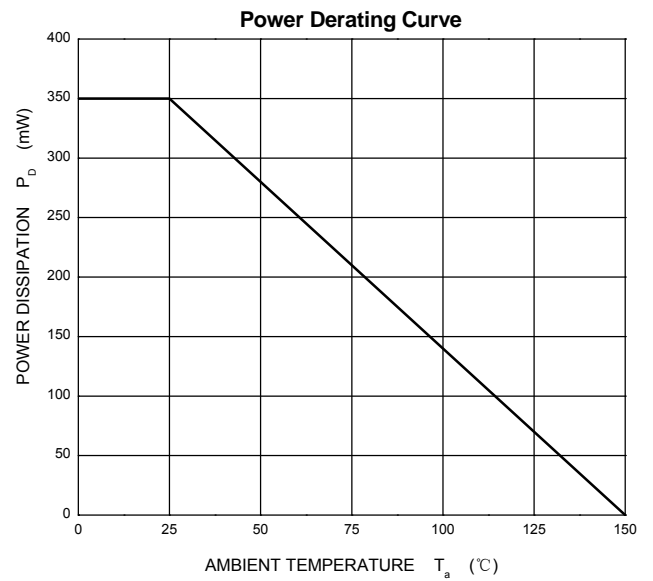
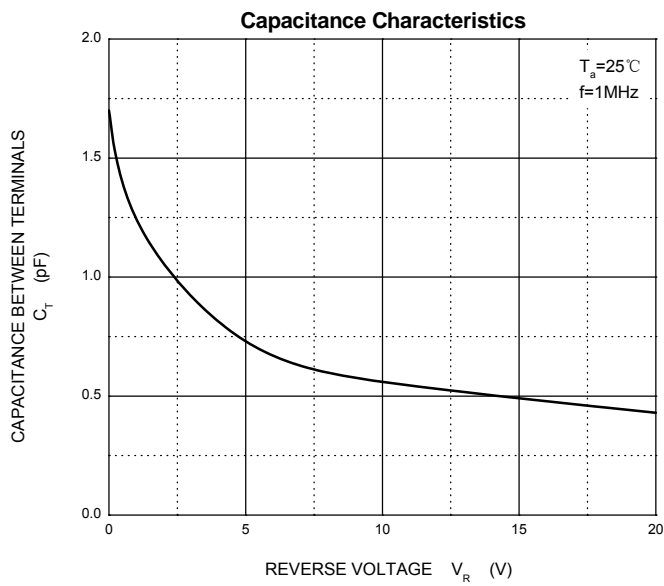
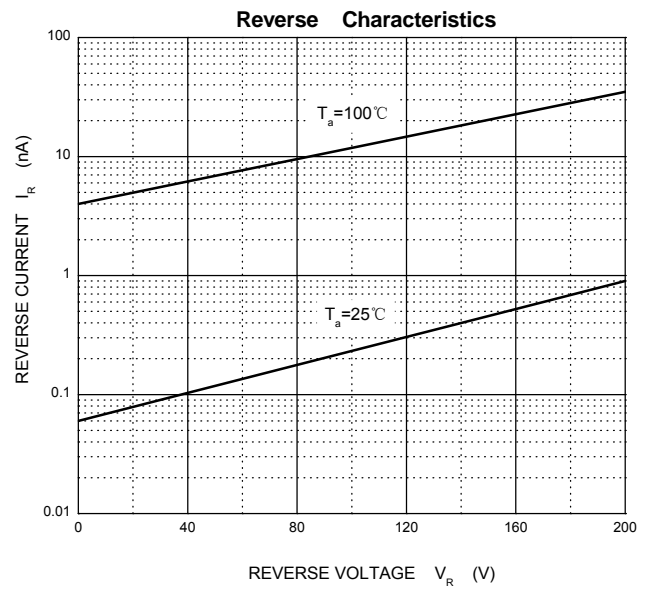
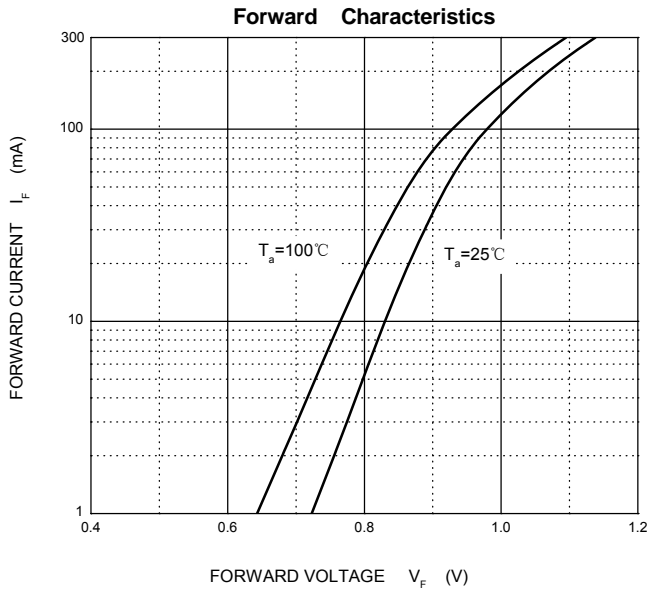

## SOT-23 Package Outline Dimensions

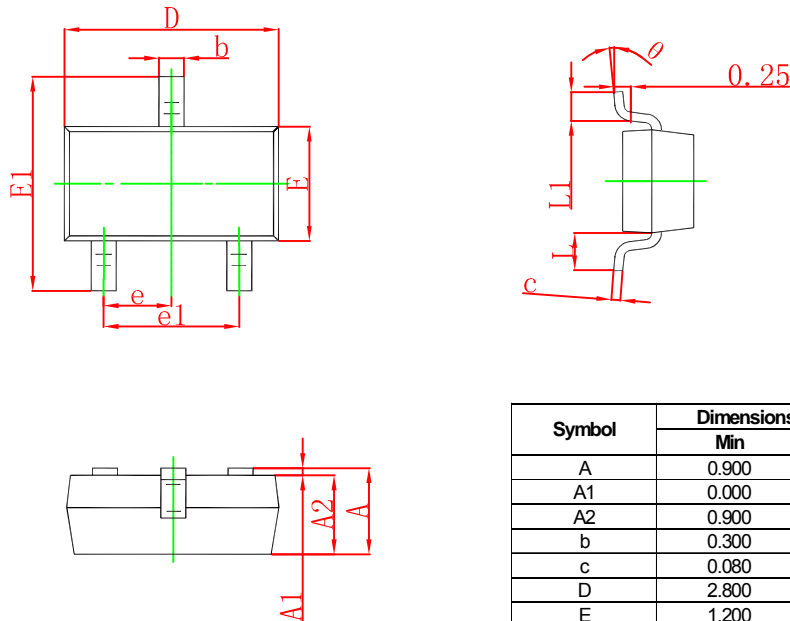

Symbol	Dimensions In Millimeters		Dimensions In Inches	
	Min	Max	Min	Max
A	0.900	1.150	0.035	0.045
A1	0.000	0.100	0.000	0.004
A2	0.900	1.050	0.035	0.041
b	0.300	0.500	0.012	0.020
c	0.080	0.150	0.003	0.006
D	2.800	3.000	0.110	0.118
E	1.200	1.400	0.047	0.055
E1	2.250	2.550	0.089	0.100
e	0.950 TYP		0.037 TYP	
e1	1.800	2.000	0.071	0.079
L	0.550 REF		0.022 REF	
L1	0.300	0.500	0.012	0.020
θ	0°	8°	0°	8°

## SOT-23 Suggested Pad Layout

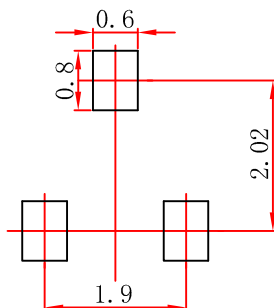

**Note:**

1. Controlling dimension: in millimeters.
2. General tolerance:  $\pm 0.05\text{mm}$ .
3. The pad layout is for reference purposes only.